

Mounting Instruction LPCA

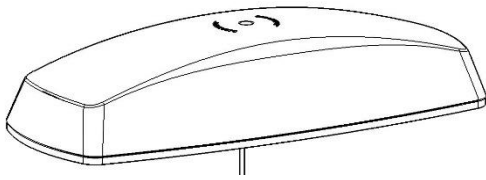

Version A (3 x mounting screws)

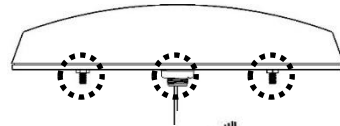

A1 – A5

Version B (1 x mounting screw)

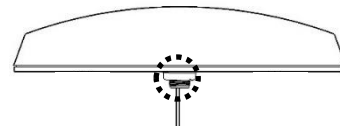

B1 – B5

A1

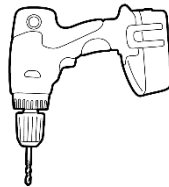

1 x Ø19mm
2 x Ø7mm

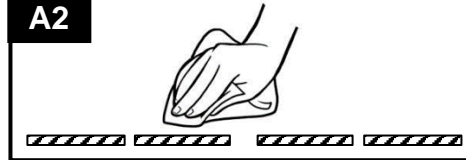
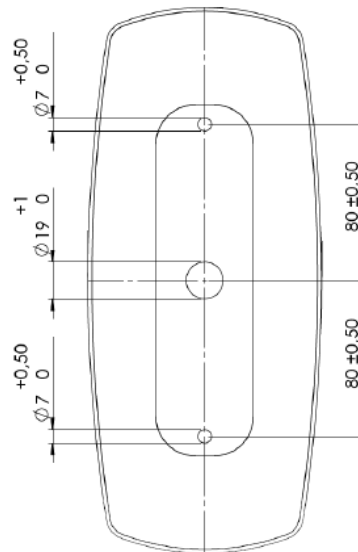

A2

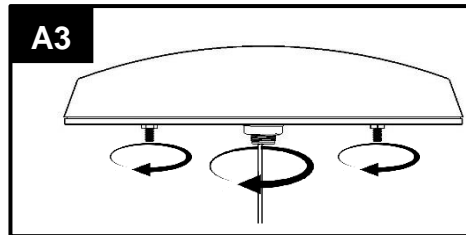

A3

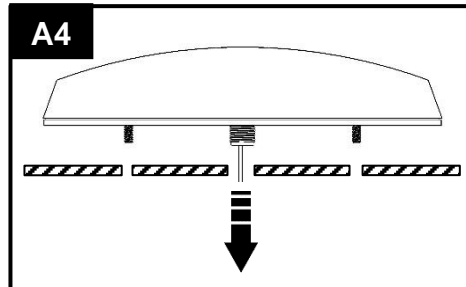

A4

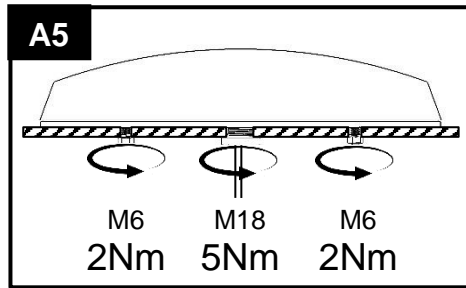

A5

M6 2Nm M18 5Nm M6 2Nm

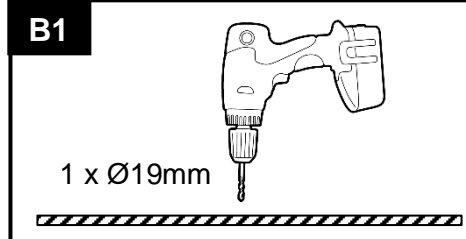

B1

1 x Ø19mm

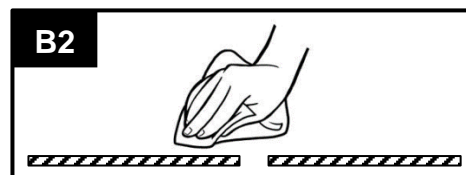

B2

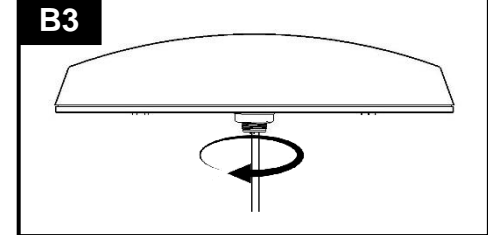

B3

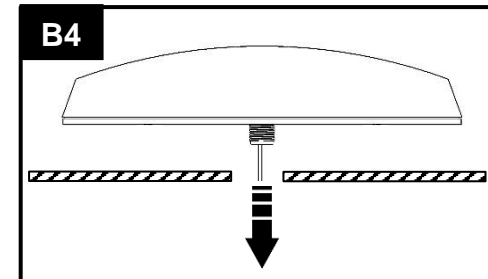

B4

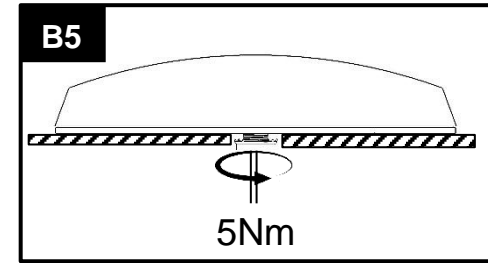

B5

5Nm

LPCA with GNSS



ATTENTION
OBSERVE PRECAUTIONS
FOR HANDLING
ELECTROSTATIC
SENSITIVE DEVICES

Hereby, Smarteq Wireless AB declares that the radio equipment type 'LPCA' is in compliance with Directive 2014/53/EU. The full text of the EU declaration of conformity is available at the following internet address:
www.smarteq.com

SMARTEQ™
WIRELESS

Kista, Sweden
www.smarteq.com
info@smarteq.com
+46 8 792 92 00

500069C

For LPCA equipped with GNSS antenna functionality

For compliance with safety requirements for information and communication technology equipment according to EN 62368-1, the following requirements shall be fulfilled:

Radiation from radio frequencies in the range 0 to 300 GHz is regulated by European Council Recommendation 1999/519/EC. The connected equipment/radio device shall in combination with LPCA comply to EN62368-1 Clause 10.Z1. Limitation of exposure of the general public to electromagnetic fields. Compliance Assessment according to EN 62479 or EN 62311.

Connected equipment/radio device shall be voltage-, current- and power limited:

The voltage and the current connected to the coaxial connectors of the antennas in LPCA shall be limited below ES- level of EN 62368-1:

- DC supply (phantom feed) voltage limited to max 6 V and current limited to max 100 mA.
- RF-signals limited to max 15 V r.m.s or 0.5 mA r.m.s

The power of the voltage and current connected to the coaxial connectors of the antennas in LPCA shall be power limited below PS1-level of EN 62368-1:

- Max 15 W d.c. or r.m.s.

The limitations of voltage, current, and power below ES1-level and PS1-level shall be fulfilled under; normal operating conditions-, abnormal operating conditions-, and single fault condition in the equipment connected to LPCA

The connected equipment/radio device shall in combination with LPCA comply to EN62368-1 Clause 5.4.5 Antenna terminal insulation for outdoor antennas.

-To comply with this requirement the connected equipment including LPCA could either be fully isolated or connected to earth at one of the antenna terminals. Isolation between mains supply of the connected equipment to LPCA and antenna terminals of LPCA shall withstand ESD of 10kV with the exception if one antenna terminal of the connected equipment is connected to earth. If one antenna terminal is connected to earth there is no insulation requirement.

- The same requirement of insulation or connection to earth at one antenna terminal applies to external circuits- and accessible circuits of the equipment connected to LPCA.



Kista, Sweden
www.smarteq.com
info@smarteq.com
+46 8 792 92 00